

# Carbón para aplicaciones eléctricas.

Las escobillas de grafito son elementos fundamentales en la transmisión de corriente de máquinas eléctricas rotativas.

La utilización de grafito en esta aplicación es debido a las propiedades especiales que posee de frotamiento, conductibilidad eléctrica y térmica, así como su comportamiento con altas temperaturas.

Nuestro asesoramiento técnico le dará la mejor solución a sus problemas, garantizándoles nuestra calidad, así como unos plazos de entrega acordes con sus necesidades.

Disponemos de diferentes tipos de calidades para las distintas aplicaciones en los siguientes sectores:

- Carbón eléctrico para máquinas industriales.
- Carbón eléctrico para máquinas de herramienta eléctrica y todo tipo de electrodomésticos.
- Carbón eléctrico para el sector del automóvil.
- Carbón eléctrico para contactos, frotadores de puente-grúa, rulinas para transformadores, etc.

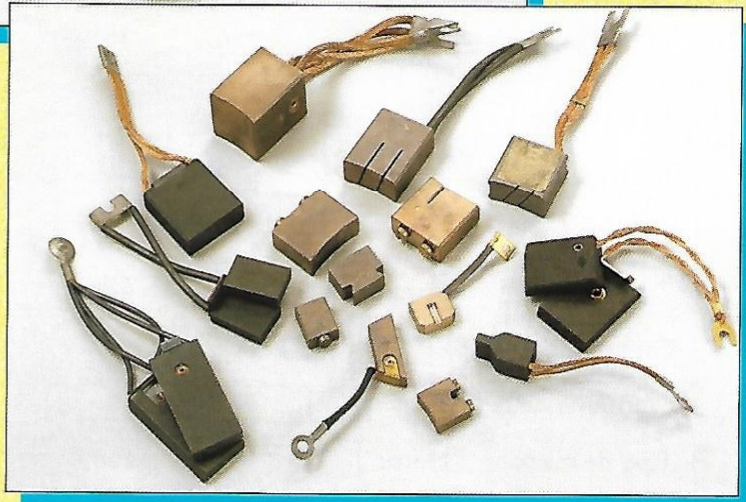
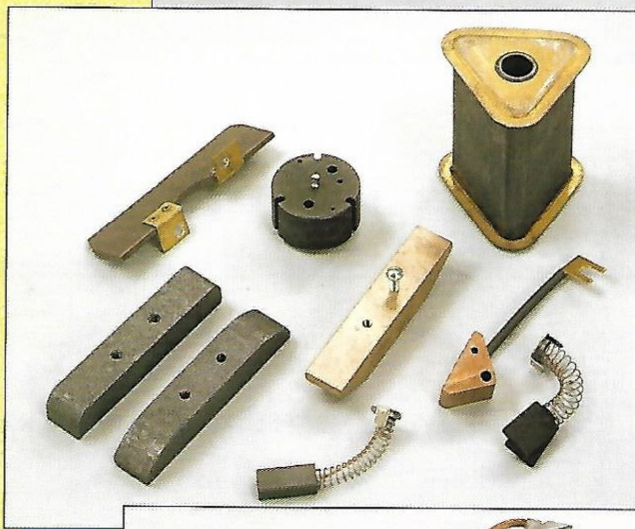

## Aplicaciones.

- Motores eléctricos de la industria en general.
- Siderúrgicas y laminaciones.
- Carretillas elevadoras eléctricas.
- Pequeña maquinaria de herramienta eléctrica, como taladros, lijadoras, amoladoras, etc...

- Motores de electrodomésticos como, lavadoras, molinillos, aspiradoras, etc...
- Distintos motores integrados en el automóvil.



## ESCOBILLAS PARA MOTORES INDUSTRIALES Y FRACCIONALES

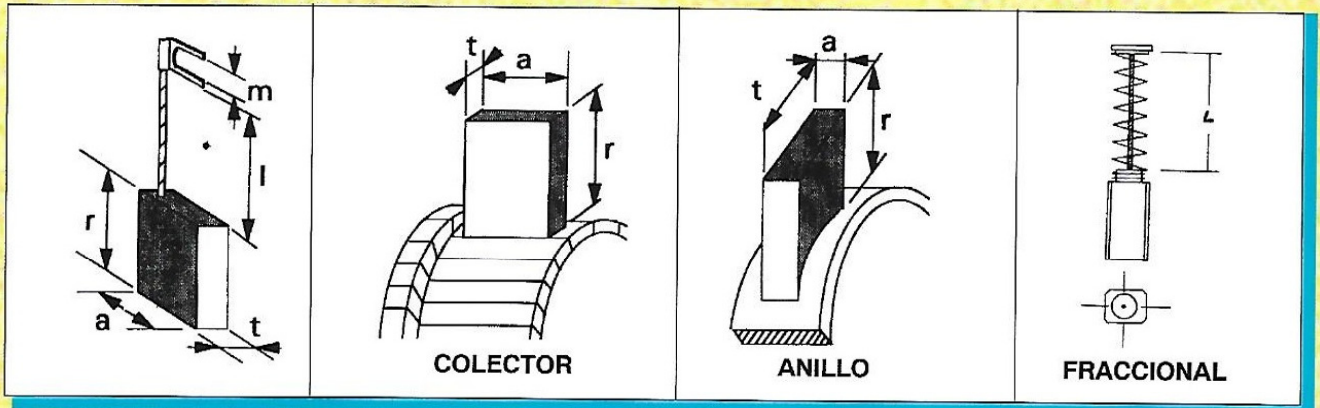

## TIPOS DE TERMINALES

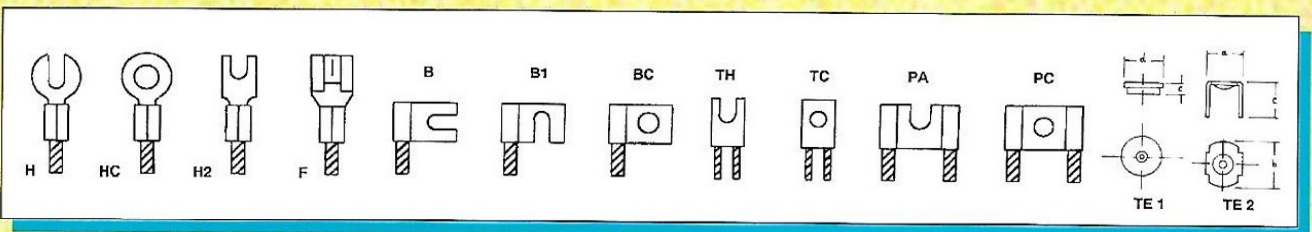

### DATOS TECNICOS

Rellenar o marcar « x » en cada casilla según lo requerido

Dibujo n.º:  (Modelos en pág. adjuntas). Si no tiene modelo, dibuje un esquema de la escobilla en este recuadro

Dimensiones:  $t$   mm  $a$   mm  $r$   mm

Longitud del cable:  $l$   mm aislado  sin aislar

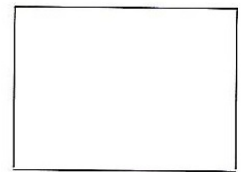

Tipo de terminal: dibujo n.º  otro   $\varnothing$  orificio/abertura del terminal  mm

Escobilla fraccional

$\varnothing$  muelle ext.  m/m  $\varnothing$  hilo  m/m n.º espiras total

Caperuza tipo TE1  TE2

Fabricante de la máquina:

Tipo:

Tipo de máquina: Motor  Generador

Corriente: continua (CC)  alterna (AC)  colector  anillo

Potencia:  Kw/cv Tensión:  v. Intensidad  amp. rpm

Intensidad en el rotor:  amp. Tensión en el rotor:  v.

N.º de polos anillos  N.º de escobillas por polo / anillo  Calidad

Descripción de la máquina:  Ref. cliente



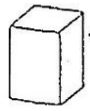

1

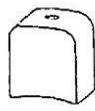

2



3



4



5

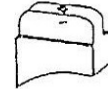

6



7



8

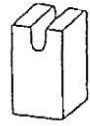

9

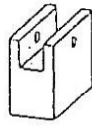

10

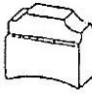

11

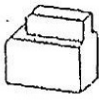

12

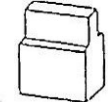

13

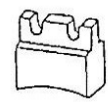

14

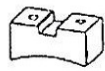

15

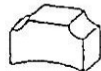

16



17



18



19



20



21

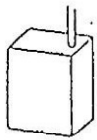

22

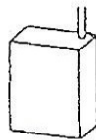

23

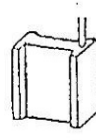

24

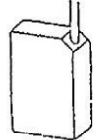

25

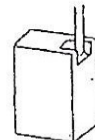

26

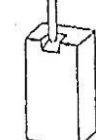

27

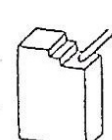

28

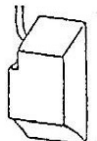

29

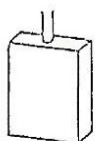

30

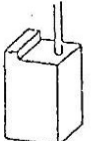

31

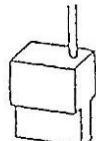

32

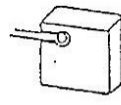

33



34



35

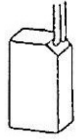

36

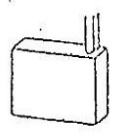

37

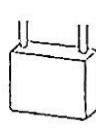

38

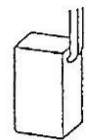

39

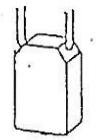

40

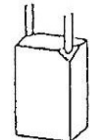

41

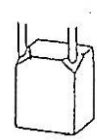

42

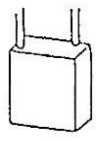

43

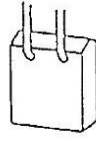

44

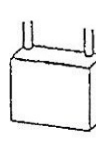

45

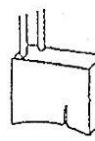

46

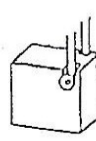

47

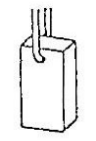

48

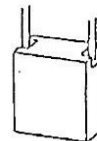

49

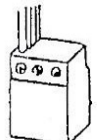

50

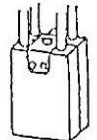

51

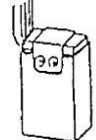

52

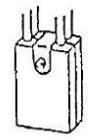

53

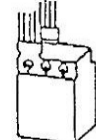

54

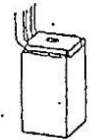

55

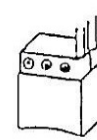

56

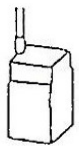

57



58

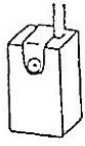

59

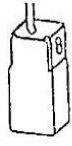

60

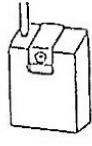

61

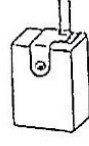

62



63



64

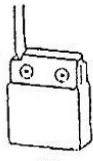

65

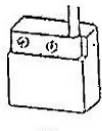

66



67



68



69



70

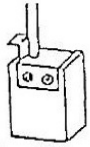

71

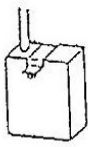

72

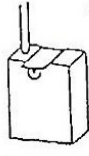

73



74

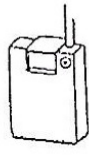

75

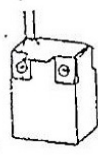

76

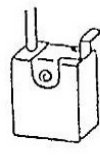

77



78



79



80

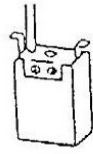

81



82



83

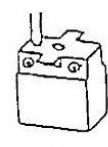

84

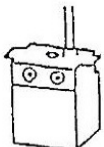

85



86

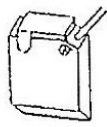

87

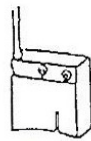

88

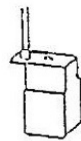

89



90

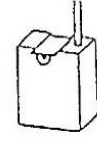

91

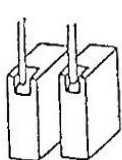

92

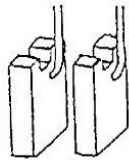

93

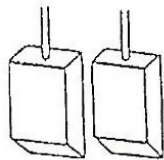

94

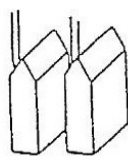

95

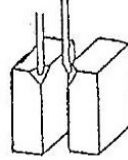

96

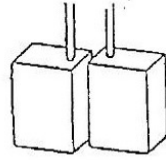

97

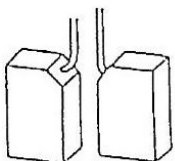

98

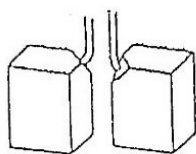

99

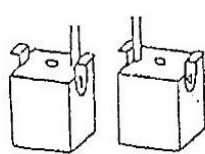

100

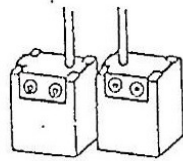

101

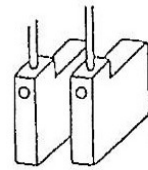

102

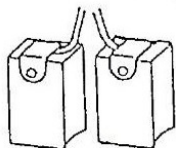

103

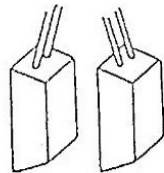

104

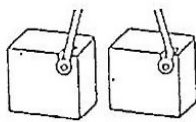

105

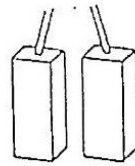

106

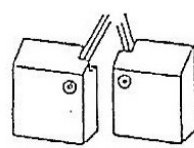

107





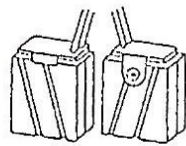

108

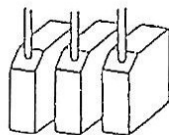

109

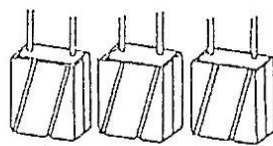

110

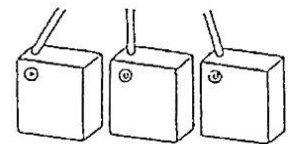

111

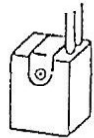

112



113

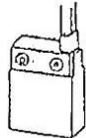

114



115



116



117

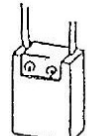

118

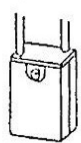

119

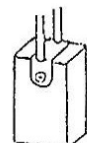

120

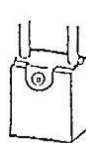

121

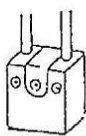

122



123

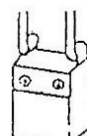

124

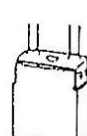

125

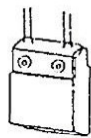

126

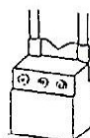

127

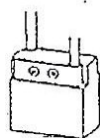

128



129

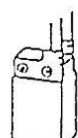

130

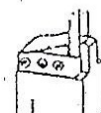

131

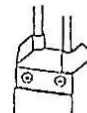

132

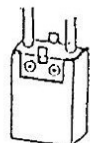

133

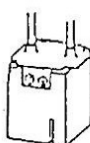

134

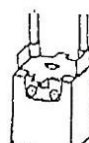

135

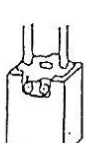

136



137

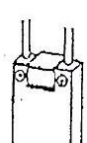

138



139

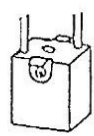

140



141

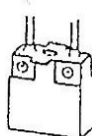

142

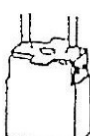

143

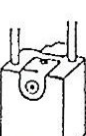

144

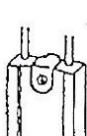

145

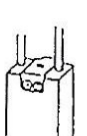

146

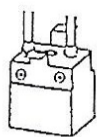

147

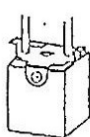

148

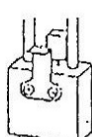

149

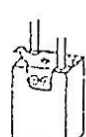

150

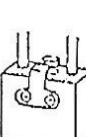

151

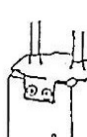

152

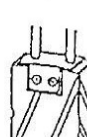

153



154

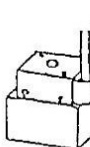

155

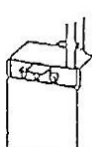

156



157

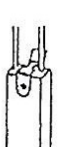

158

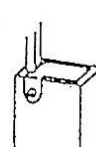

159

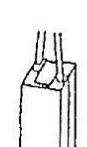

160



161

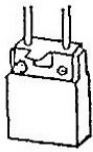

162

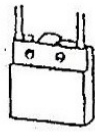

163

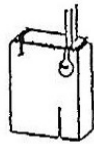

164



165

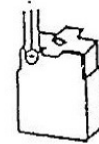

166

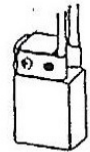

167

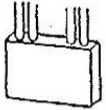

168

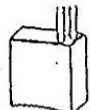

169

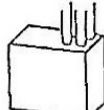

170

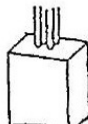

171



172

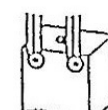

173

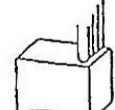

174

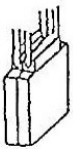

175

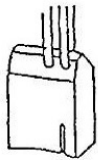

176

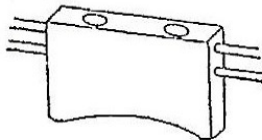

177

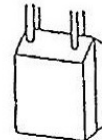

178



179

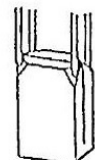

180

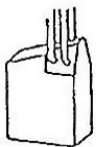

181

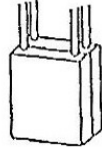

182

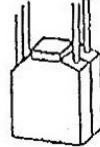

183

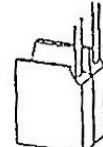

184

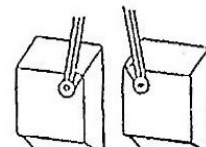

185

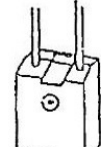

186

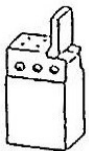

187

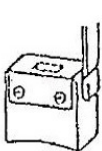

188

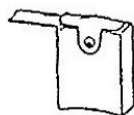

189

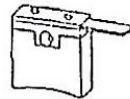

190

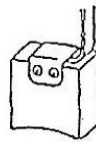

191

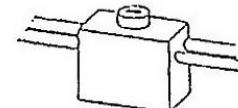

192



193

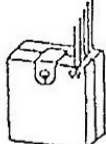

194

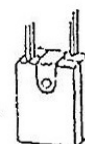

195



196

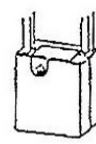

197

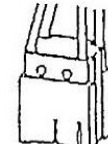

198

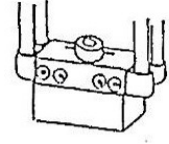

199



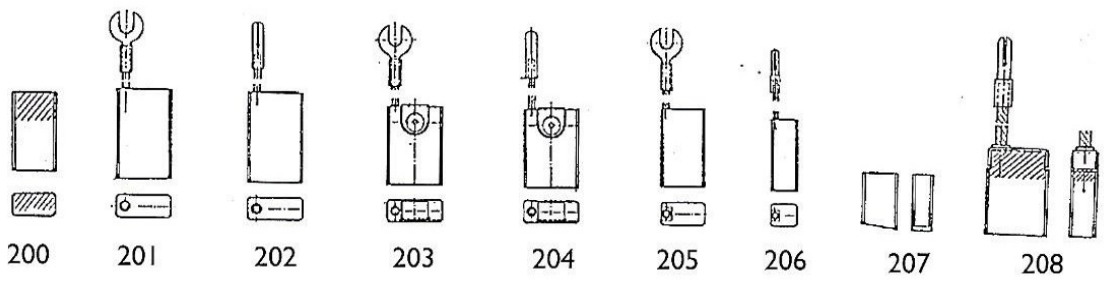

200 201 202 203 204 205 206 207 208

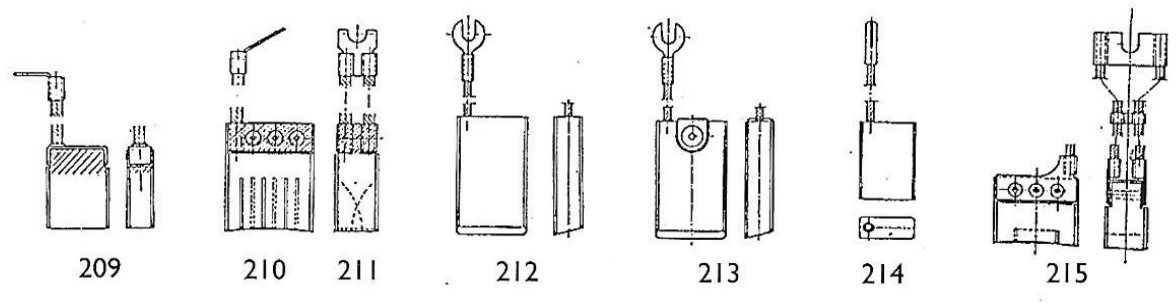

209 210 211 212 213 214 215

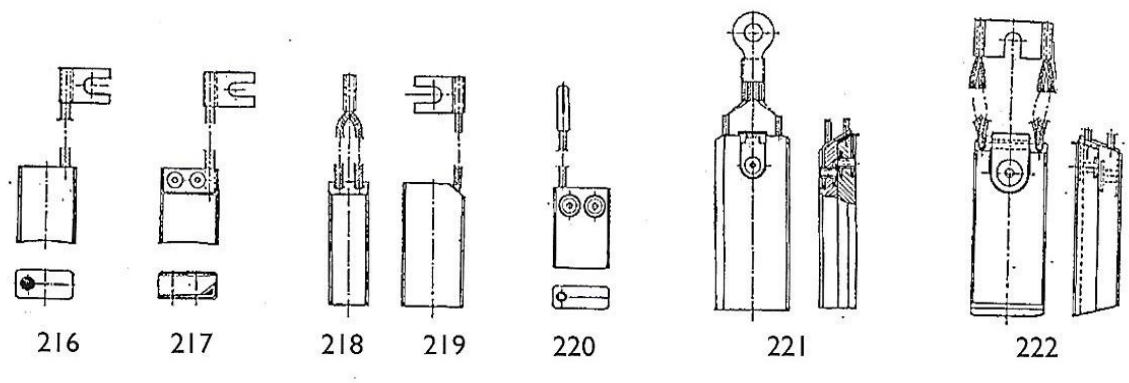

216 217 218 219 220 221 222

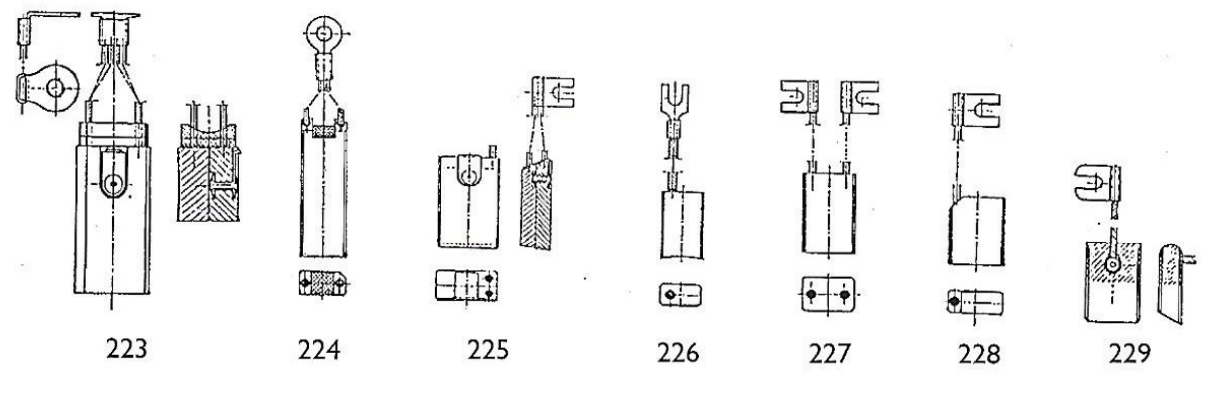

223 224 225 226 227 228 229

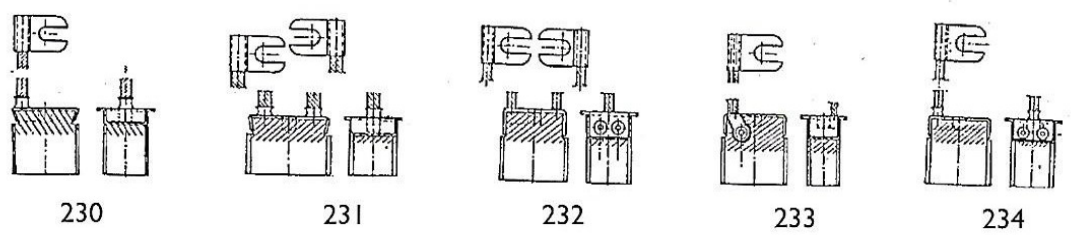

230 231 232 233 234

Empresa / Nombre \_\_\_\_\_ E-mail \_\_\_\_\_  
 Contacto \_\_\_\_\_ Teléfono \_\_\_\_\_

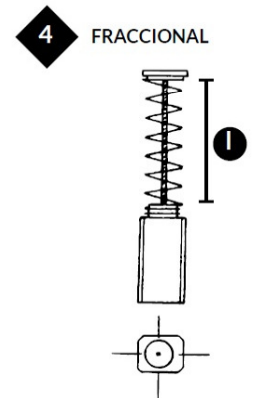
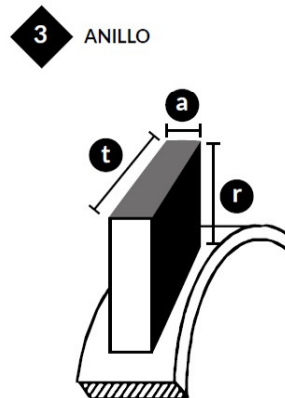
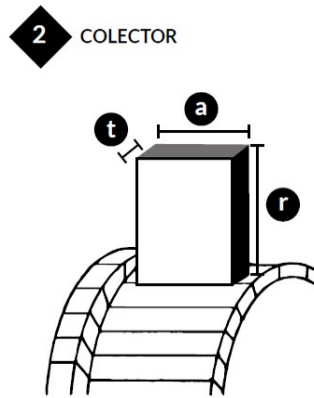
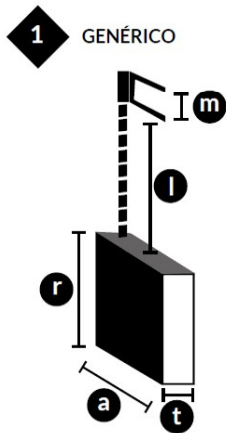

Medidas en mm:

t: \_\_\_\_\_  
 a: \_\_\_\_\_  
 r: \_\_\_\_\_  
 m: \_\_\_\_\_  
 l: \_\_\_\_\_

**5** CROQUIS ESCOBILLA Describalo brevemente y/o mándenos una foto o dibujo

Número de cables:

aislado  sin aislar

Marque el tipo de terminal que más se parece:

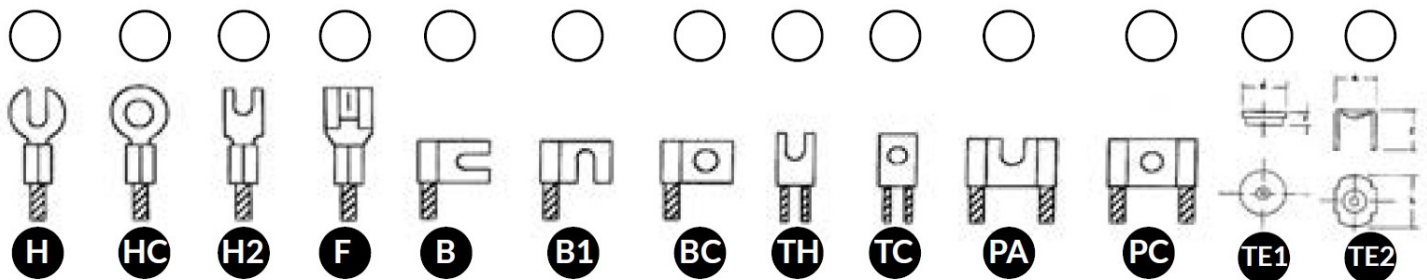

Caperuza:

Otro:

Otros datos técnicos necesarios: (rellene todo lo que le sea posible)

Fabricante de la máquina \_\_\_\_\_ Tipo \_\_\_\_\_ Descripción \_\_\_\_\_

Motor \_\_\_\_\_ Generador \_\_\_\_\_ Corriente: Continua - DC  Alterna - AC  Colector  Anillo

Potencia (Kw/cv) \_\_\_\_\_ Tensión (v) \_\_\_\_\_ Intensidad (amp) \_\_\_\_\_ rpm \_\_\_\_\_

Intensidad del rotor (amp) \_\_\_\_\_ Tensión en el rotor ( $V_r$ ) \_\_\_\_\_ Nº de polos/anillos \_\_\_\_\_

Nº escobillas por polo / anillo \_\_\_\_\_ Calidad \_\_\_\_\_ Cantidad Total \_\_\_\_\_ Ref. Cliente \_\_\_\_\_

Comentarios: